

**INSTALLATION INSTRUCTIONS  
CASE 621-621B  
LOADERS**

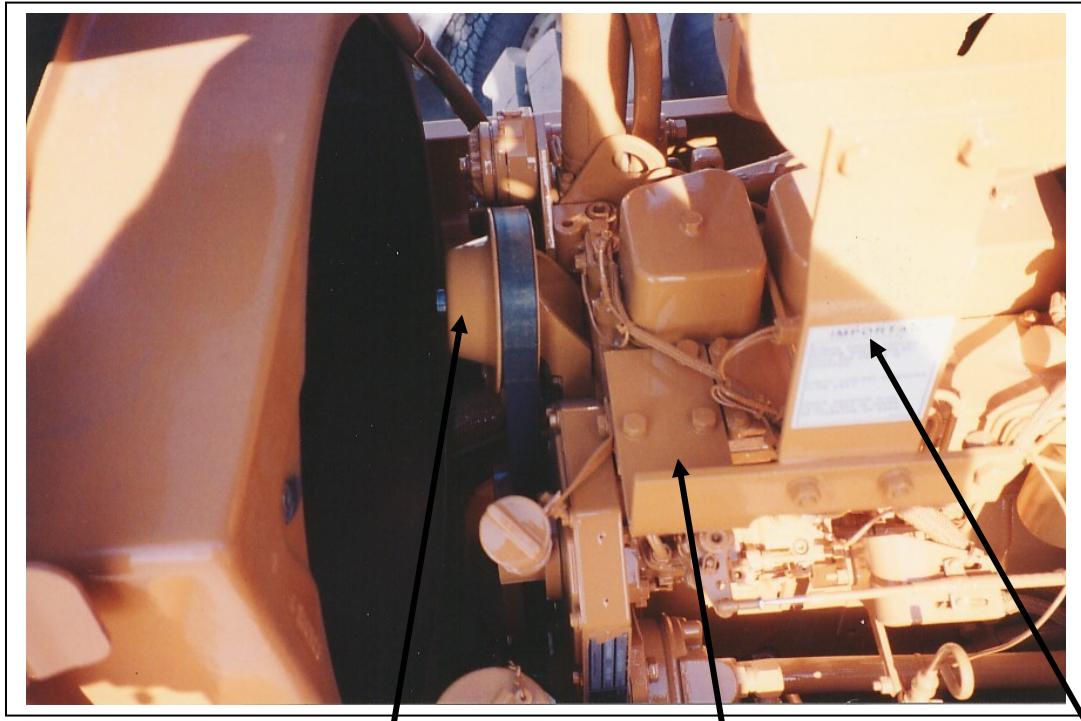

**PHONE: (519) 485-5961 OR 1-800-267-2665  
FAX: (519) 485-3745 OR 1-888-267-3745**

## COMPRESSOR



Install pulley on fan hub

Compressor mount goes here

Remove this bracket for compressor installation. (replace after)



Compressor mount in place without 2" spacer

The 2" spacer is used depending on the fuel injection lines and the exhaust support bracket. The extra height will give the necessary clearances on newer machines.





Compressor

1/2" fitting

13/32" fitting

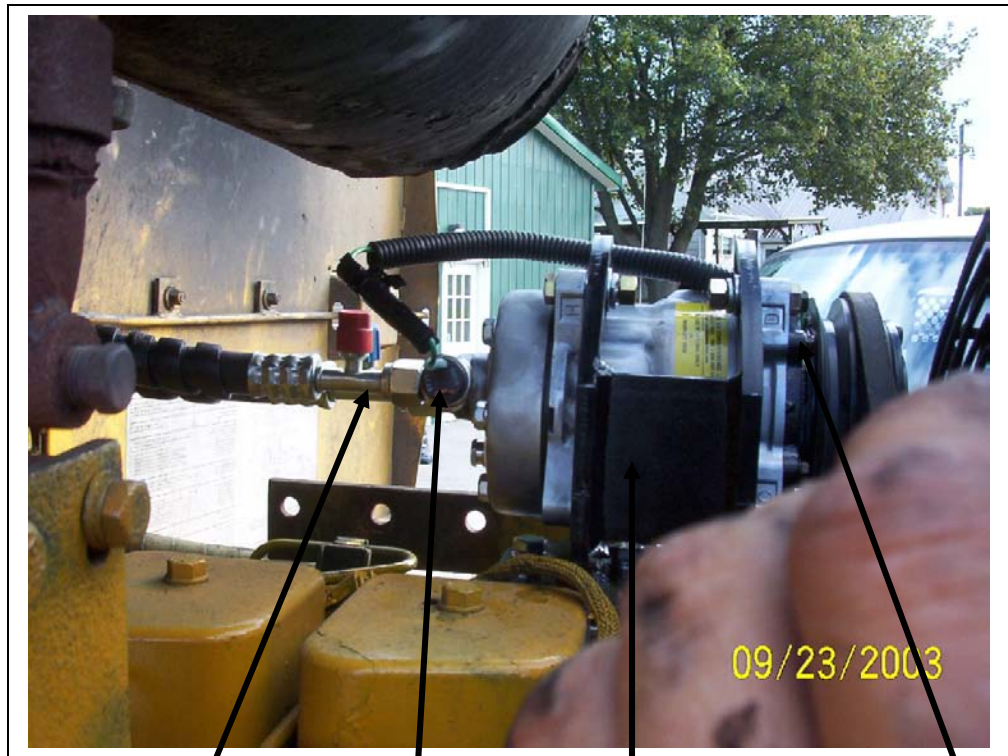

13/32" fitting

Binary switch

Compressor mount

Compressor



Compressor in place without 2 inch spacer



Compressor in place with 2:” 2” spacer 1/2” and 13/32” lines spacer





1/2" hose

13/32" hose

Receiver drier

## CONDENSER



Bolts holding condenser brackets in place



Condenser brackets on left side of radiator



Condenser bolts to threaded holes on radiator flange

Hole drilled in bottom of fan shroud for A/C hoses

Condenser in place between fan and radiator



# EVAPORATOR

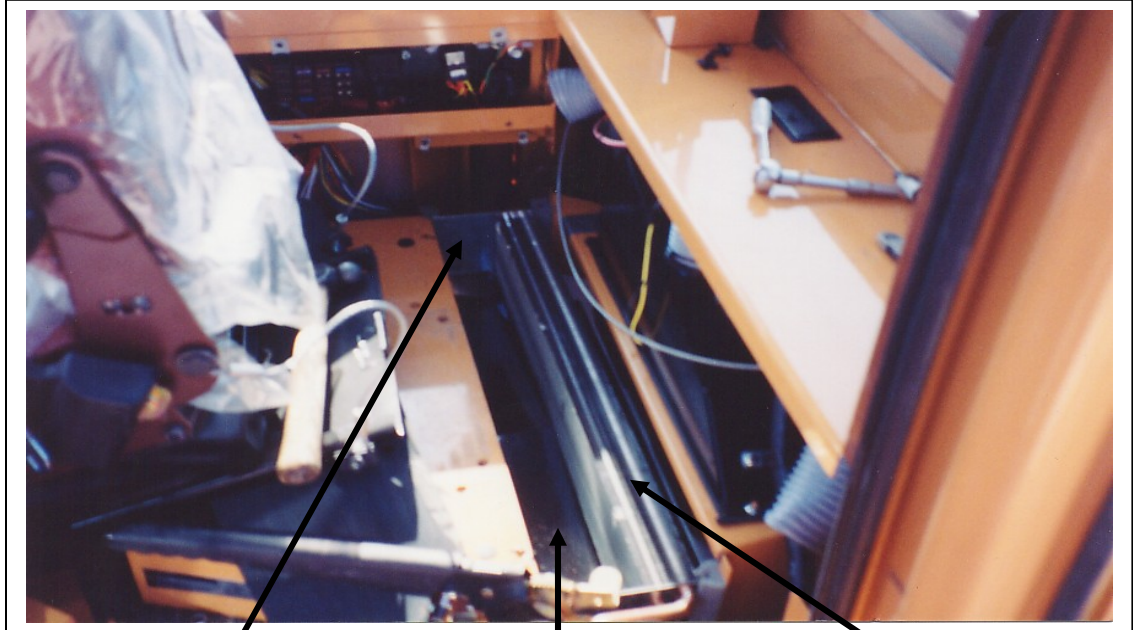

Notch out this flange to allow A/C coil fittings through

Evaporator coil area

Heater coil

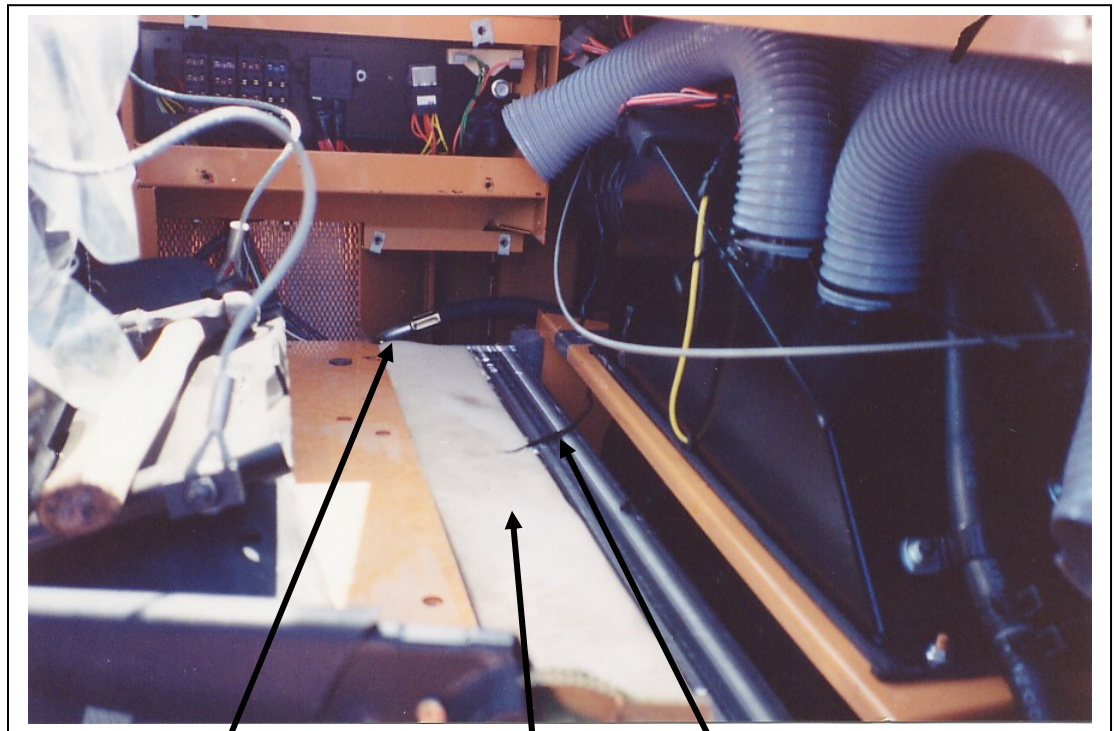

Fitting end of coil

Evaporator coil in place

Thermostat probe





A/C hoses entering the cab

Drain tubes

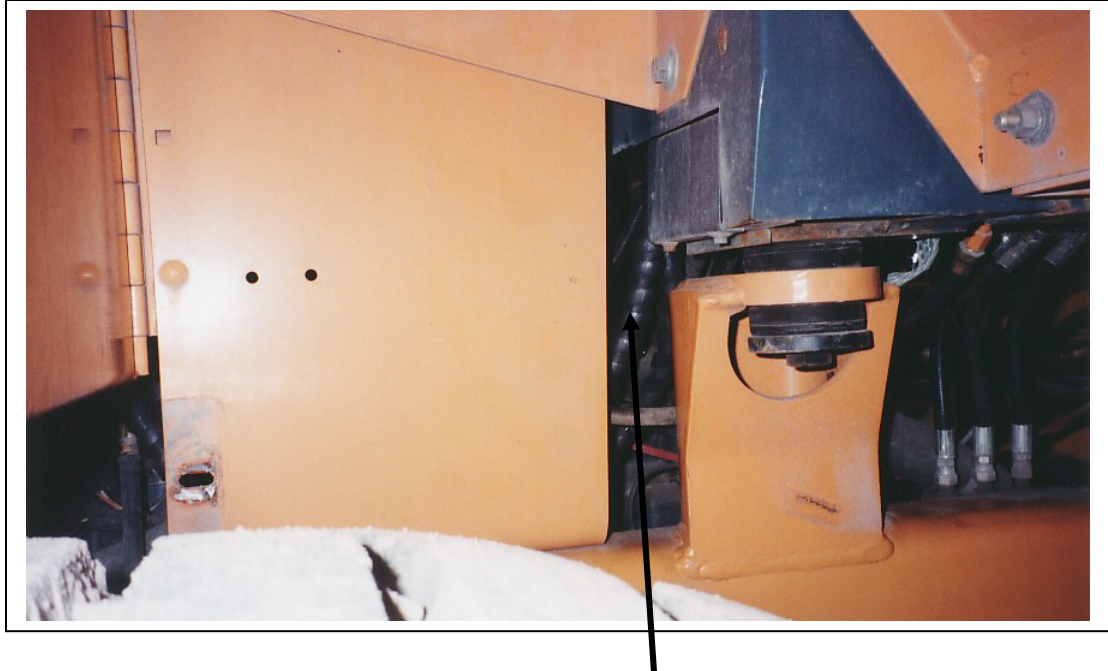

A/C hoses entering the cab

## ELECTRICAL

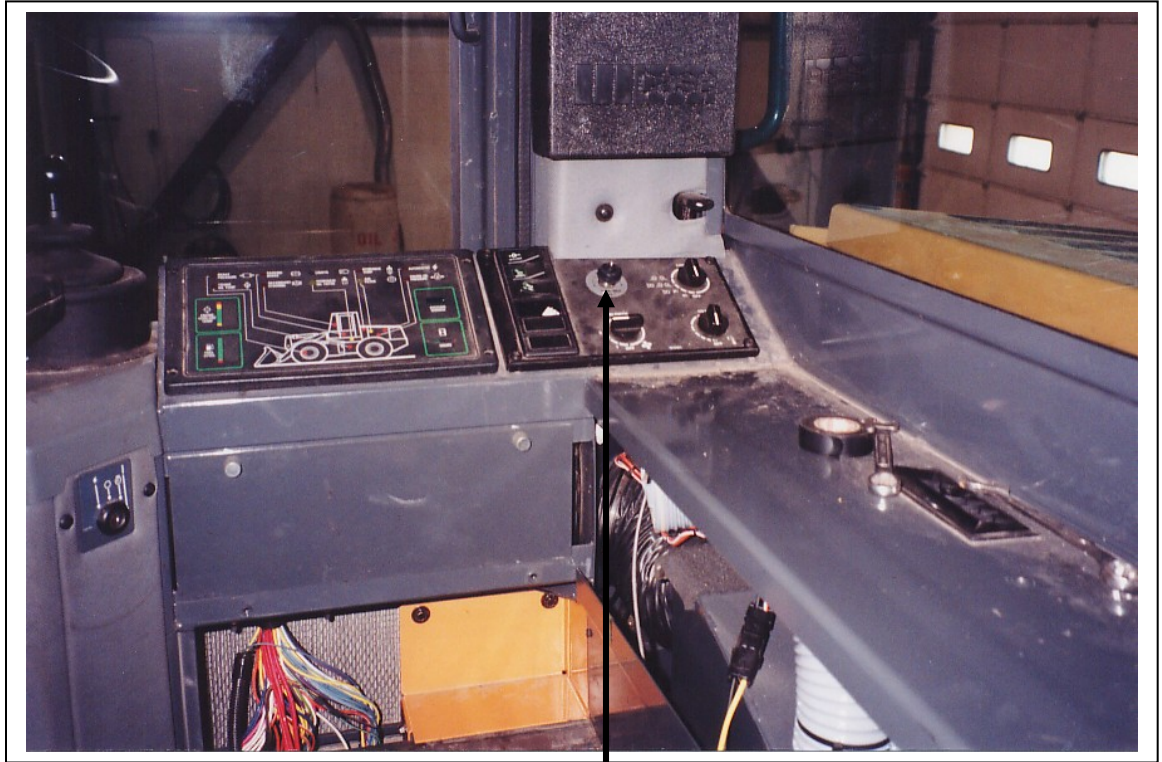

Thermostat in place

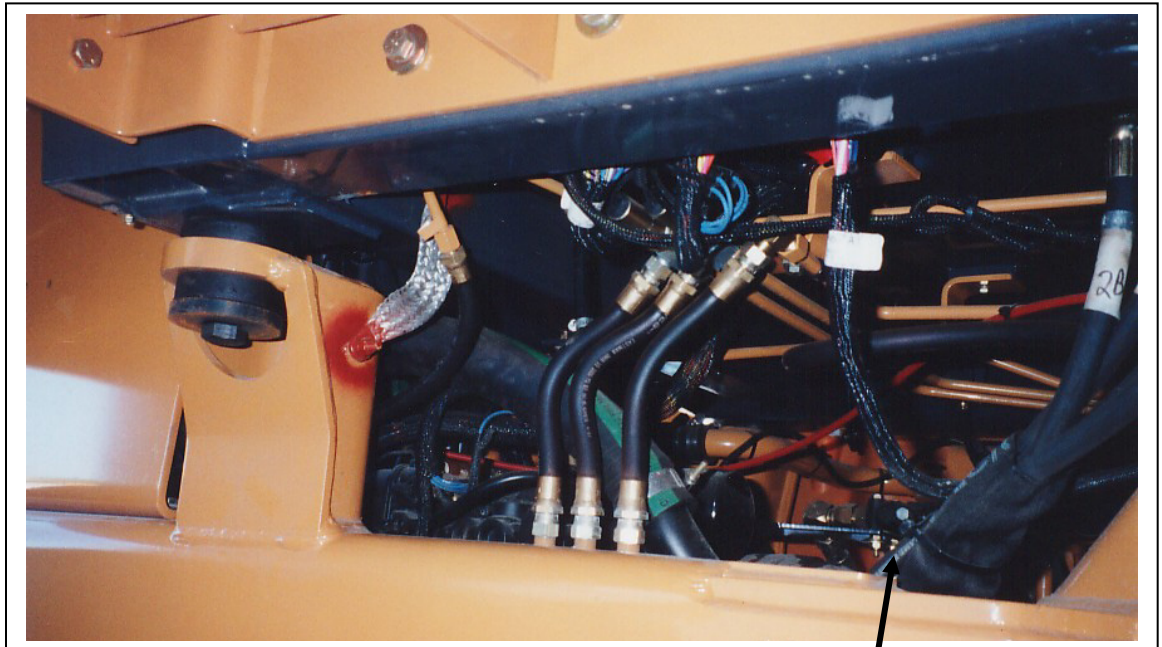

Clutch wire going up towards the electrical compartment in the cab



Wiring diagram 621B CASE

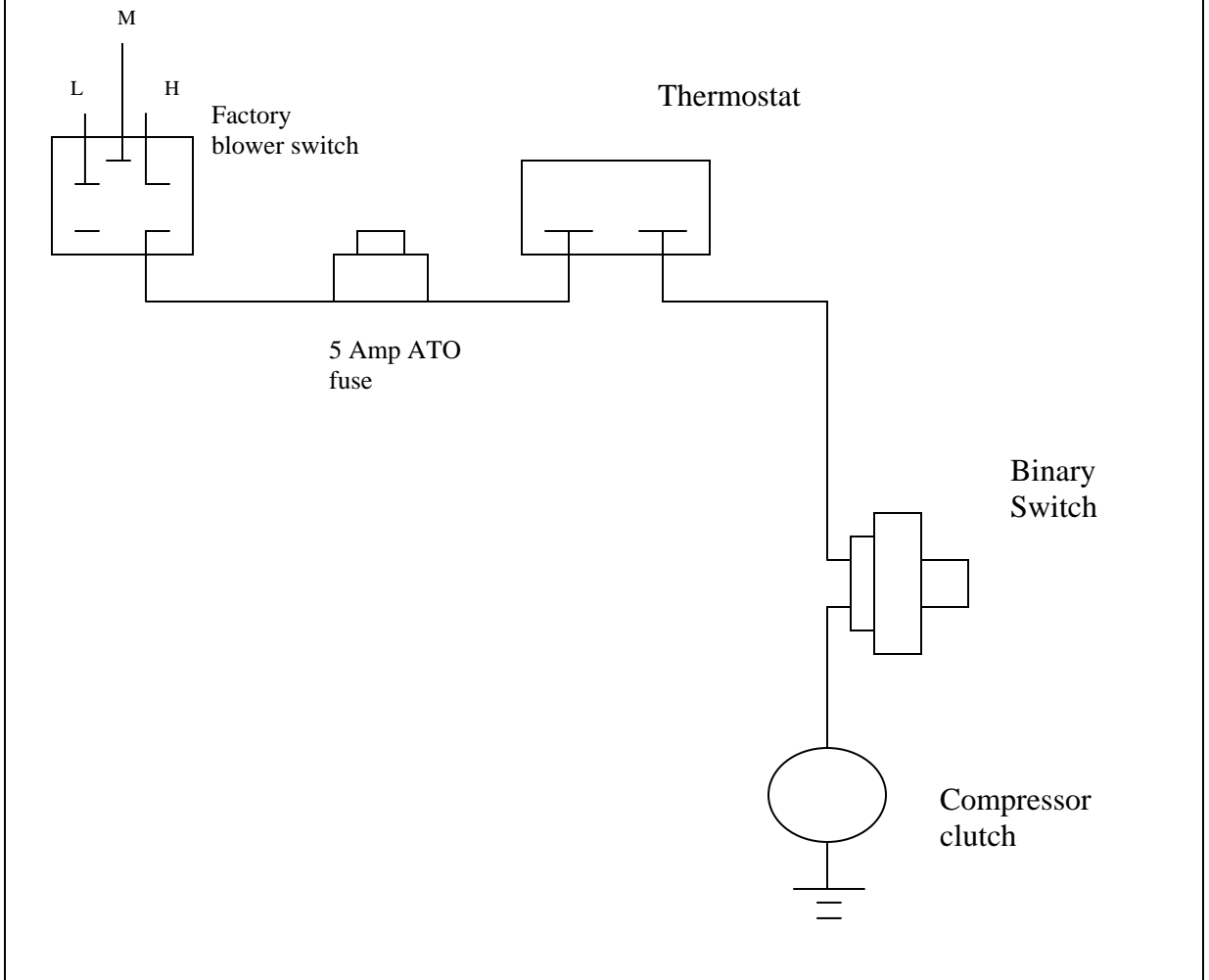

## Refrigerant Flow Pattern in a Standard Air Conditioning System

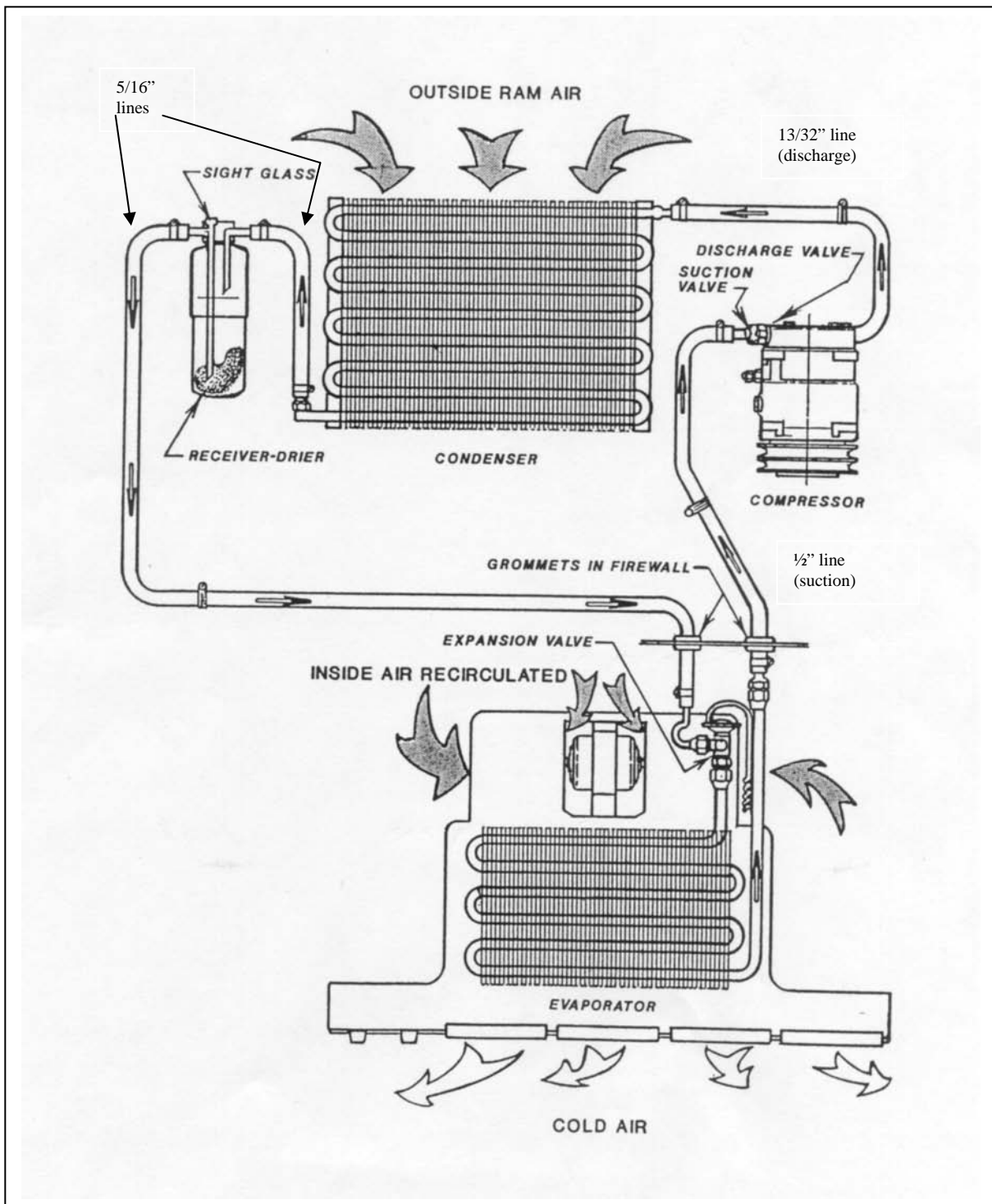



## Thermostat Setting Procedures

- 1) Thermostat types
  - a) preset
  - b) adjustable
    - a) A preset thermostat is adjusted to its specific cut in and cut out temperatures when manufactured and does not have a rotary adjustment for the operator.
    - b) An adjustable or rotary thermostat has been manufactured to a predetermined cut in and cut out temperatures, but it is also operator adjustable to achieve the desired comfort level.

Both types of thermostats can have their factory settings adjusted by turning the setting screws on the body of the thermostat. One body type has the setting screws mounted externally and labeled for direction of rotation. The other body type requires the removal of the plastic end plate to expose the set screw.

- 2) Thermostat probe location: The location of the thermostat probe in an evaporator coil can be very important to achieve the maximum cooling potential of the coil while also preventing coil freeze-up. There is no set location for the thermostat probe to be put that will be optimum for all systems, but several rules of thumb may be followed:
  - a) Insert the probe in the coldest area of the evaporator coil.
  - b) Insert the probe from the top of the coil down, if possible.
  - c) Make sure that at least the last 3" of the thermostat probe are in the coil.

To find the most likely area where the coil is the coldest, consider these factors:

- 1) Direction of air flow through the coil.
  - 2) The coil area likely to have the lowest air flow.
  - 3) The inlet locations of the refrigerant into the coil.
  - 4) The inlet of the hotter outside air into the coil area.
- 
- 1) Usually the coldest side of the evaporator coil will be the air outlet side. Often the thermostat probe can be inserted between the last and second last row of tubes.
  - 2) The lower air flow area of the evaporator coil in most systems tends to be near either end of the coil. These areas will be colder
  - 3) The area of the coil that the refrigerant inlet tube(s) occupy should be the coldest part of the coil.
  - 4) If the system is equipped with an outside air intake, where and how that air is brought into the evaporator area can have a large effect on the coil temperature. If all the outside air is piped into the evaporator in one area, that area will be considerably warmer in hot weather.

By looking at all these different factors, the area of an evaporator coil most likely to be the coldest can be determined.

Once the probe is inserted, the A/C system needs to be tested. Run the system to ensure that the thermostat is cycling the compressor off at the appropriate temperature. A core temperature ranging between 25° and 30° F should cause the thermostat to cycle off. The air temperature at the vent outlet closest to the evaporator coil should be between 38° F and 45° F when the compressor cycles off.

If the thermostat doesn't cycle off after a reasonable cool down period, and the air outlet temperature has dropped below 40° F, the cut in and cut out settings should be adjusted until the compressor is cycling on and off regularly. Let the system run for a decent time period (at least 15 min) and then check the evaporator coil for any signs of freezing.